

市场部 MARKETING

公司地址: 广东省佛山市三水中心科技工业区C区25号
No.25, Zone C, Sanshui Central Hi-tech Industrial Park, Foshan City, Guangdong Province, P.R.China
电话(Tel): 0757-87336617
邮箱(E-mail): ypl@hltpress.com al@hltpress.com
网址(Website): http://www.hltpress.com

服务部 SERVICE CENTER

国内24小时服务热线Domestic 24-hour service hotline : 18155590658
服务电话Service hotline : 86-757- 87336617

配件供应中心 SPARE PARTS SUPPLY CENTER

地址: 广东省佛山市三水中心科技工业区C区25号
No.25, Zone C, Sanshui Central Hi-tech Industrial Park, Foshan City, Guangdong Province, P.R.China
电话(Tel): 0757-87336617
邮箱(E-mail): newpress@hltpress.com
网址(Website): http://www.hltpress.com

全国各地售后服务部 SERVICE BRANCHES

广东售后服务部 电话(tel):0757-87653968/13703068322	河北高邑售后服务部 电话(tel):0311-84037581/18931981988	河南汝州售后服务部 电话(tel):13827795101
山西阳城售后服务部 电话(tel):13827795101	四川夹江售后服务部 电话(tel):0833-5688640/13981306730	陕西咸阳售后服务部 电话(tel):0913-8612081/13892921953
山东淄博售后服务部 电话(tel):0533-2975791/13964489133	云南易门售后服务部 电话(tel):0877-4961208/13987737009	广西藤县售后服务部 电话(tel):0774-7296944/18977476944
山东临沂售后服务部 电话(tel):13854953069	福建闽清售后服务部 电话(tel):0591-22463940/13809533061	湖北当阳售后服务部 电话(tel):0717-3229873/15897536255 18931981988
辽宁法库售后服务部 电话(tel):13998133411	福建晋江售后服务部 电话(tel):0595-85070049/13808519394	湖南岳阳售后服务部 电话(tel):0730-7502955/15115082020
辽宁法库售后服务部大石桥分点 电话(tel):13998133411	江西高安售后服务部 电话(tel):0795-5281196/13767566866	贵州售后服务部 电话(tel):0851-82577650/13688505761
安徽芜湖售后服务部 电话(tel):13854953069		

海外售后服务 SERVICE OFFICE OF OVERSEAS DIVISION

印度售后服务部 SERVICE OFFICE OF INDIA
Add: HLT INDIAN OFFICE: (Morbi, Rajkot, Gujarat) Shop number-103, 104, 1st floor, Adhyashaki chamber, NH-8,
Near honest hotel, Lalpar, Morvi, Gujarat (India) 363642
Tel: +91-9925923721
Tel: +91-9512228085

越南售后服务部 SERVICE OFFICE OF VIETNAM
Add: Duong 310B, Thon Luong Cau, Xa Son Loi, Binh Xuyen, Vinh Phuc, Viet nam

印度尼西亚售后服务部 SERVICE OFFICE OF INDONESIA
Add: HLT INDONESIA OFFICE KOMPLEKS RUKAN BUARAN PERSADA NO.20 JI. JEND R.S
SUKAMTODUREN SAWIT Jakarta 13450 INDONESIA
Telp: +62-21-86612832-33



2023年06月印刷。画册的图片及参数仅供参考, 恒力泰有权修改, 恕不预先通知。
June 2023 Revision. The drawings and parameters are for reference only.
HLT reserves the right to introduce changes without notice.

HLT 恒力泰
HENGLITAI
—— 始创于1957 / SINCE 1957 ——

铝型材挤压机

ALUMINUM PROFILE EXTRUSION PRESS



佛山市恒力泰机械有限公司
HLT Industry Co., Ltd.

企业荣誉 COMPANY HONOR

02

企业简介 BRIEF INTRODUCTION

03

产品优势 PRODUCT ADVANTAGE

05

成熟先进的生产制造体系
MATURE AND ADVANCED MANUFACTURING SYSTEM

07

健全有效的质量保证体系
SOUND AND EFFECTIVE QUALITY CONTROL SYSTEM

09

生产过程执行管理系统 (MES)
MANUFACTURING EXECUTION SYSTEM

11

产品介绍 PRODUCT INTRODUCTION

12

主体部分 MAIN BODY OF THE PRESS

21

液压泵站, 电气控制系统
HYDRAULIC PUMP STATION ELECTRONIC SYSTEM

22

压机智能管理系统
PRESS INTELLIGENT MANAGEMENT SYSTEM

23

压机专用液压油 PRESS HYDRAULIC OIL

24

优质零备件 QUALITY SPARE PARTS

25

挤压工艺
EXTRUSION PROCESS

27

挤压机系列基本参数
BASIC PARAMETERS OF ALUMINUM EXTRUSION PRESS SERIES

28

售后服务 AFTER-SALES SERVICE

29

部分客户展示 CUSTOMERS SHOW

30



佛山市恒力泰机械有限公司【科达制造（股票代码：600499）的全资子公司，以下简称：恒力泰或公司】是专业从事自动液压机研发制造的民营企业，源于1957年，迄今已有60多年的历史，是国家高新技术企业、国家火炬计划重点高新技术企业、全国制造业单项冠军企业、中国建材机械20强企业、广东省装备制造业50骨干企业、广东省战略性新兴产业（智能制造）骨干企业、中国专利奖和佛山市政府质量奖获奖企业。

公司于1988年研制成功600吨级的液压自动压砖机，荣获国家科技进步奖。恒力泰生产的陶瓷压砖机是陶瓷生产企业的核心和关键设备，整体技术处于“国内领先、国际先进”水平，荣获国家级、省（部）级多项殊荣，是全国制造业单项冠军产品、中国陶瓷行业名牌产品、中国建材机械行业名牌产品、国家重点新产品、广东省高新技术产品和广东省名牌产品，产品覆盖国内各陶瓷主产区，并远销到亚洲、欧洲、非洲和美洲的30多个国家和地区，在国际上具有极高知名度，连续16年占据全球市场占有率的领先地位。

恒力泰建有省级工程技术研究中心和省级企业技术中心，是陶瓷砖自动液压机和透水砖自动液压机行业标准的负责起草单位，也是耐火砖自动液压机行业标准的参与起草单位。公司专注自动液压机研发制造三十余载，目前已形成从600吨~36000吨共50多个规格型号的陶瓷压机、耐火砖压机、铝型材挤压机、墙体砖压机等系列产品，具备年产各类压机700台的能力，具有雄厚的研发生产实力，至今已出厂各类自动液压机接近九千台。

2017年恒力泰公司开始进军铝型材挤压机装备行业，经过技术调研充分了解了各种生产工艺，经过精心研发及制做，首先成功推出了YPL2000铝型材挤压机，现已成功推出了YPL1100、YPL1500、YPL2500、YPL2750、YPL3000、YPL3300、YPL3600、YPL4000、YPL4500、YPL5000、YPL5500、YPL6000、YPL7500、YPL10000等系列铝型材挤压机。

恒力泰有着六十余年的装备研发和生产技术沉淀及品牌影响力。展望未来，佛山市恒力泰机械有限公司将与各界同仁携手合作，伴随国家“一带一路”发展战略，积极参与国际市场竞争，为继续做强做大中国机械装备产业作出贡献。

HLT Industry Co., Ltd. [a wholly-owned subsidiary of KEDA Industrial Group Co., Ltd. (stock code: 600499), hereinafter referred to as: HLT] is a private enterprise specializing in the research and development and manufacturing of automatic hydraulic presses. It was established in 1957 and has been more than 60 years history. It is a national high-tech enterprise, a key high-tech enterprise of the National Torch Program, a single champion enterprise in the national manufacturing industry, a top 20 Chinese building materials machinery enterprise, a 50 backbone enterprise in the equipment manufacturing industry of Guangdong Province, and a strategic emerging industry in Guangdong Province (Intelligent Manufacturing) Key Enterprise, China Patent Award and Foshan Municipal Government Quality Award Winning Enterprise.

The company successfully developed a 600-ton hydraulic automatic brick press in 1988 and won the National Science and Technology Progress Award. The ceramic tile press produced by HLT is the core and key equipment of ceramic manufacturers. The overall technology is at the level of "domestic leading and international advanced". It has won many national and provincial (ministerial) awards, and is a single champion in the national manufacturing industry. famous-brand products in China's ceramic industry, famous-brand products in China's building materials machinery industry, national key new products, high-tech products in Guangdong Province, and famous-brand products in Guangdong Province. The products cover the main ceramic production areas in China and are exported to more than 30 countries and regions in Asia, Europe, Africa and Americas, are well-known internationally, and have occupied a leading position in the global market share for 16 consecutive years.

HLT has a provincial engineering technology research center and a provincial enterprise technology center. It is responsible for drafting the industry standards for ceramic tile automatic hydraulic presses and permeable brick automatic hydraulic presses, and is also a participating unit in drafting industry standards for refractory brick automatic hydraulic presses. The company has focused on the development and manufacture of automatic hydraulic presses for more than 30 years. At present, it has formed more than 50 specifications and models of ceramic presses, refractory brick presses, aluminum extrusion presses, wall brick presses and other products ranging from 600 tons to 36,000 tons. It has the ability to produce 700 units of various types of presses per year, and has strong R&D and production capabilities. So far, HLT has been provided nearly 9,000 units of various automatic hydraulic presses to the customers.

In 2017, HLT began to enter the aluminum profile extrusion press equipment industry. After technical investigations, fully understood various production processes, and careful research and development and manufacturing, it first successfully launched the YPL2000 aluminum extrusion press, and now has been successfully launched YPL1100, YPL1500, YPL2500, YPL2750, YPL3000, YPL3300, YPL3600, YPL4000, YPL4500, YPL5000, YPL5500, YPL6000, YPL7500, YPL10000 etc. the series of aluminum extrusion presses.

HLT has more than 60 years of equipment R&D and production technology precipitation and brand influence. Looking forward to the future, HLT will work hand in hand with colleagues from all walks of life to actively participate in international market competition along with the national "One Belt One Road" development strategy, and contribute to the continued strengthening and expansion of China's machinery and equipment industry.



动态调速系统

- 力士乐高频响、高精度伺服变量泵与变频电机（伺服电机）相结合，同时兼顾了速度调节的精确度、快速性和节能性，速度调节灵敏度高，恒速控制精度高，大幅提升产品质量，降低能耗。
- Frequency conversion type volumetric speed control**
- The combination of Rexroth's high-frequency response, high-precision servo variable pump and variable frequency motor, while taking into account the accuracy, rapidity and energy saving of speed adjustment, speed adjustment with high sensitivity, constant speed control with high accuracy, is conducive to improve product quality and reduce energy consumption.

短行程紧凑式主机

- 极为紧凑的框架，带来更高的精度与更小的变形
 - 同时提高了挤压头和挤压筒的使用寿命，减少了液压油使用量，发热损失小，提高了速度控制的精度，缩短了非挤压辅助时间。
- Short-stroke compact main frame structure**
- The compact frame has better accuracy and smaller deformation.
 - Improves the service life of the extrusion head and the container, reduces the amount of hydraulic oil used, and reduces heat loss, improves the accuracy of speed control, and shortens the non-extrusion auxiliary time.

全预应力主体框架结构

- 大大提高了挤压机架的结构强度和整体刚性，有效保证机架的疲劳寿命，有利于保证制品的质量。
- Complete prestressed main frame structure**
- Greatly improve the structural strength and overall rigidity of the extruder frame, effectively guarantee the fatigue life of the frame, and helpful to ensure the quality of the product.

突破工艺优化

- 通过挤压周期的曲线分析，优化从突破到正常挤压的时间，提高有效生产时间的占比，降低废品率，
- Breakthrough technology optimizing**
- With analysis of extrusion cycle curve, optimize the time from breakthrough to extrusion, improve the proportion of effective production time, and the scrap rate is reduced.

更短的非挤压时间

- 领先的非挤压时间，
 - 动作逐项分析，针对非挤压周期每个动作进行优化控制，
 - 大幅提高生产效率。
- Shorter dead cycle time**
- Leading in non-extrusion time in the industry,
 - Action by action analysis, optimize and control each action of the non-extrusion cycle,
 - Greatly improve production efficiency.

零焊接系统

- 所有高压钢管全部采用装配结构，焊缝数量为“0”
 - 严格的加工装配，使得液压系统的可靠性更高，故障率更低。
- Non-welded system**
- All high-pressure steel pipes are assembled and "0" weld.
 - Strict processing and assembly make the hydraulic system more reliable and lower failure rate

绿色辅助系统

- 大量辅助机构的伺服化，设备动作更加平顺高效
 - 符合碳中和的发展趋势，电动、气动的大量应用，使得液压油污染进一步减少，更加绿色环保。
- Green auxiliary system**
- The servoization of a large number of auxiliary mechanisms makes equipment movements smoother and more efficient
 - In line with the development trend of carbon neutrality, a large number of electric and pneumatic applications, making hydraulic oil pollution further reduced, more green and environmental protection

移动式压余剪（选配）

- 铲刀回程时，不会将铲刀上的残余料污染到模具端面，保证合模可靠性并减少挤压缺陷。
- Moveable butt shear(Optional)**
- When the blade returns, the residual material on the blade will not be contaminated to the end face of the mold, which ensures the reliability of mold clamping and reduces extrusion defects.

锻造前梁

- 极佳的刚性，使得模具在挤压时的变形更小，有利于保证制品质量，降低废品率。
- Forged front beam**
- The excellent rigidity makes the deformation of the mold smaller during extrusion, which is conducive to ensuring the quality of the product, reduce the rate of waste.

模座锁紧系统

- 确保压余剪切干净均匀，有利于可靠合模和多孔挤压控制。
- Die stack locking device**
- Equipped with a die stack locking device to ensure the butt is sheared cleanly and evenly, which is conducive to reliable mold clamping and multi-hole extrusion control.

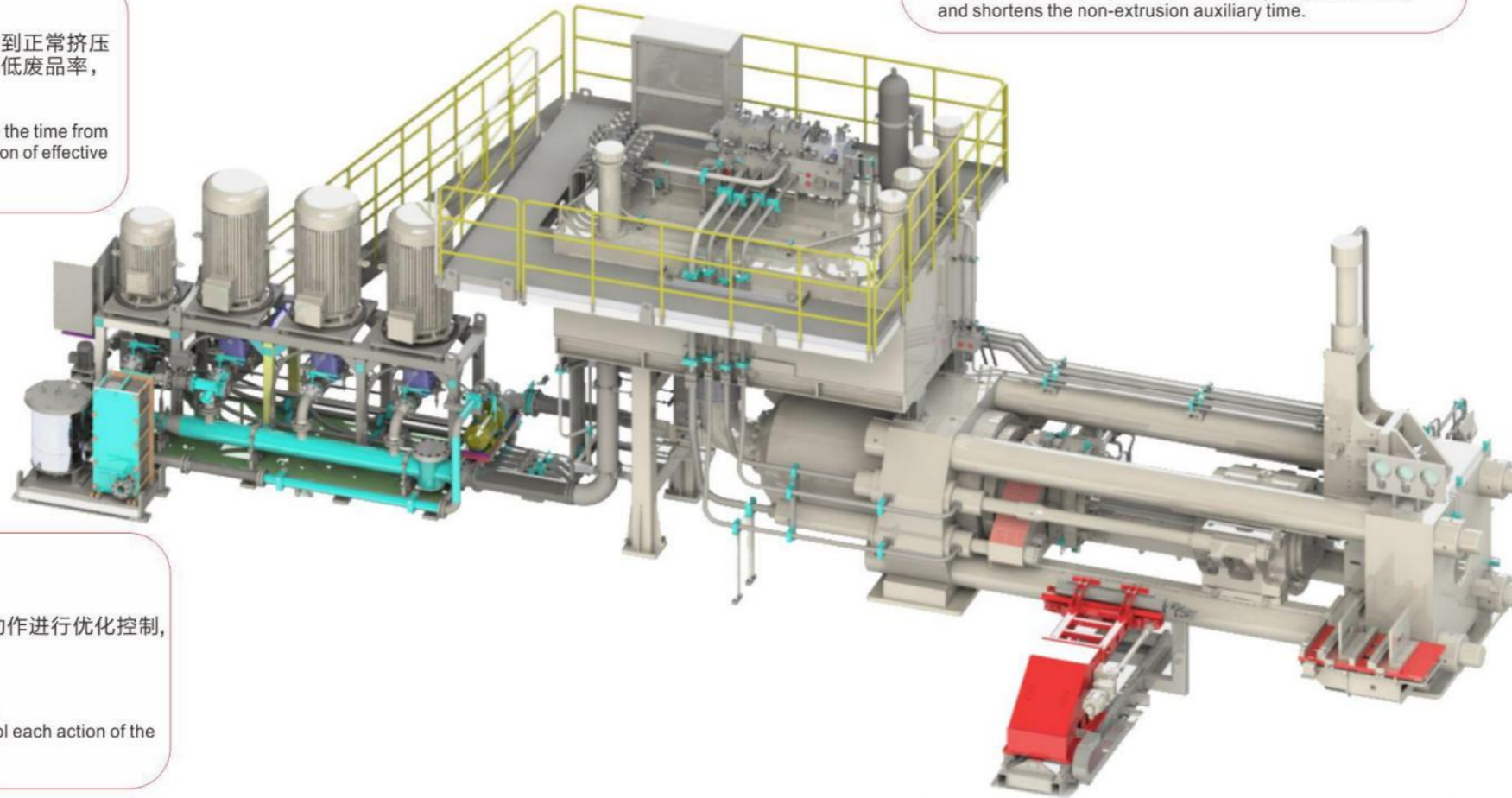

成熟先进的生产制造体系

MATURE AND ADVANCED MANUFACTURING SYSTEM

专业生产自动液压机三十余载，对自动液压机中的主关件具有丰富的生产制造经验和独到的核心技术，保证零部件的加工精度与装配效果，提高设备工作的稳定性、可靠性。

Specializing in the production of automatic hydraulic press for more than 30 years, HLT has rich manufacturing experience and unique core technology for the main components of automatic hydraulic press, ensuring the processing accuracy and assembly effects of parts and components, and improving the stability and reliability of equipment



2米龙门加工中心
2M GANTRY MACHINING CENTER



2.5米数控立车
2.5M CNC VERTICAL LATHE



125卧式加工中心
125 HORIZONTAL MACHINING CENTER



6920数控镗床
6920 BORNING MACHINE



深孔钻床
DEEP HOLE DRILLING MACHINE



马扎克双主轴车铣复合
MAZAK DOUBLE SPINDLE TURNING AND MILLING COMPOUND MACHINE



斯图特复合磨床—KC33
STUDER COMPOUND GRINDING MACHINE



8米数控卧车
8M CNC BEDDING EQUIPMENT



4米立车
4M VERTICAL LATHE



8米数控龙门铣
8M CNC GANTRY MILLING MACHINE

健全有效的质量保证体系

SOUND AND EFFECTIVE QUALITY CONTROL SYSTEM

铝型材挤压机在制造过程中每一个环节都要经过严格的质量把关，确保每一个制造环节都能够满足相关要求，铝型材挤压机在制造过程质量的把控从材料进货、零件的加工、装配、整机试验都必须达到相关标准要求，同时对每一台机都进行全生命周期的质量管理。

Every step in the manufacturing process of the aluminum extrusion press must undergo strict quality control to ensure that each manufacturing step can meet the relevant requirements. The quality of the aluminum extrusion press in the manufacturing process is controlled include the purchase of materials and the processing of components, assembling and testing of the whole machine, which must meet the requirements of relevant standards. At the same time, the quality management of the whole life cycle is carried out for each machine.



主要部件运行精度检测

OPERATION ACCURACY DETECTION OF MAIN COMPONENTS



零件金相组织分析

METALLOGRAPHIC ANALYSIS OF COMPONENTS



主机装配精度检测

PRESS ASSEMBLY ACCURACY DETECTION



无损硬度检测

NON-DESTRUCTIVE HARDNESS TESTING



粗糙度检测与分析

ROUGHNESS DETECTION AND ANALYSIS

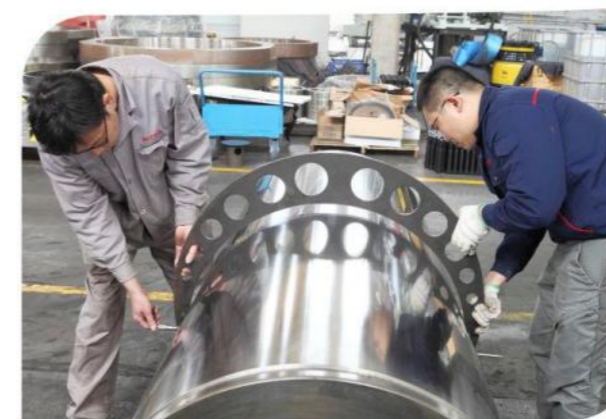

零件关键部位尺寸检测

DIMENSIONAL INSPECTION OF KEY PARTS OF COMPONENTS



零件超声波探伤检验

ULTRASONIC INSPECTION OF COMPONENTS



零件尺寸检测

SIZE INSPECTION OF COMPONENT



零件化学成分检测与分析

CHEMICAL COMPOSITION DETECTION AND ANALYSIS OF COMPONENTS



YPL1500

正向单动挤压机

SINGLE ACTION DIRECT EXTRUSION PRESS

压机结构 Press structure	上料方式 Loading method	非挤压时间 Non extrusion time	最大挤压力 (MT) Maximum extrusion force	装机功率 (kW) Installed power
短行程后上料 short stroke back loading	伺服机械手 servo billet loader	11.5s	1500	~360



YPL2000

正向单动挤压机

SINGLE ACTION DIRECT EXTRUSION PRESS

压机结构 Press structure	上料方式 Loading method	非挤压时间 Non extrusion time	最大挤压力 (MT) Maximum extrusion force	装机功率 (kW) Installed power
短行程后上料 short stroke back loading	伺服机械手 servo billet loader	12.5s	2000	~565



YPL2500

正向单动挤压机

SINGLE ACTION DIRECT EXTRUSION PRESS

压机结构 Press structure	上料方式 Loading method	非挤压时间 Non extrusion time	最大挤压力 (MT) Maximum extrusion force	装机功率 (kW) Installed power
短行程后上料/前上料 short stroke back/ front loading	伺服机械手 servo billet loader	15.5s	2500	~680



YPL2750

正向单动挤压机

SINGLE ACTION DIRECT EXTRUSION PRESS

压机结构 Press structure	上料方式 Loading method	非挤压时间 Non extrusion time	最大挤压力 (MT) Maximum extrusion force	装机功率 (kW) Installed power
短行程后上料/前上料 short stroke back/ front loading	伺服机械手 servo billet loader	16.5s	2750	~700



YPL3000

正向单动挤压机

SINGLE ACTION DIRECT EXTRUSION PRESS

压机结构 Press structure	上料方式 Loading method	非挤压时间 Non extrusion time	最大挤压力 (MT) Maximum extrusion force	装机功率 (kW) Installed power
短行程前上料 short stroke front loading	伺服机械手 servo billet loader	17s	3000	~720



YPL3300

正向单动挤压机

SINGLE ACTION DIRECT EXTRUSION PRESS

压机结构 Press structure	上料方式 Loading method	非挤压时间 Non extrusion time	最大挤压力 (MT) Maximum extrusion force	装机功率 (kW) Installed power
短行程前上料 short stroke front loading	伺服机械手 servo billet loader	17.5s	3300	~740

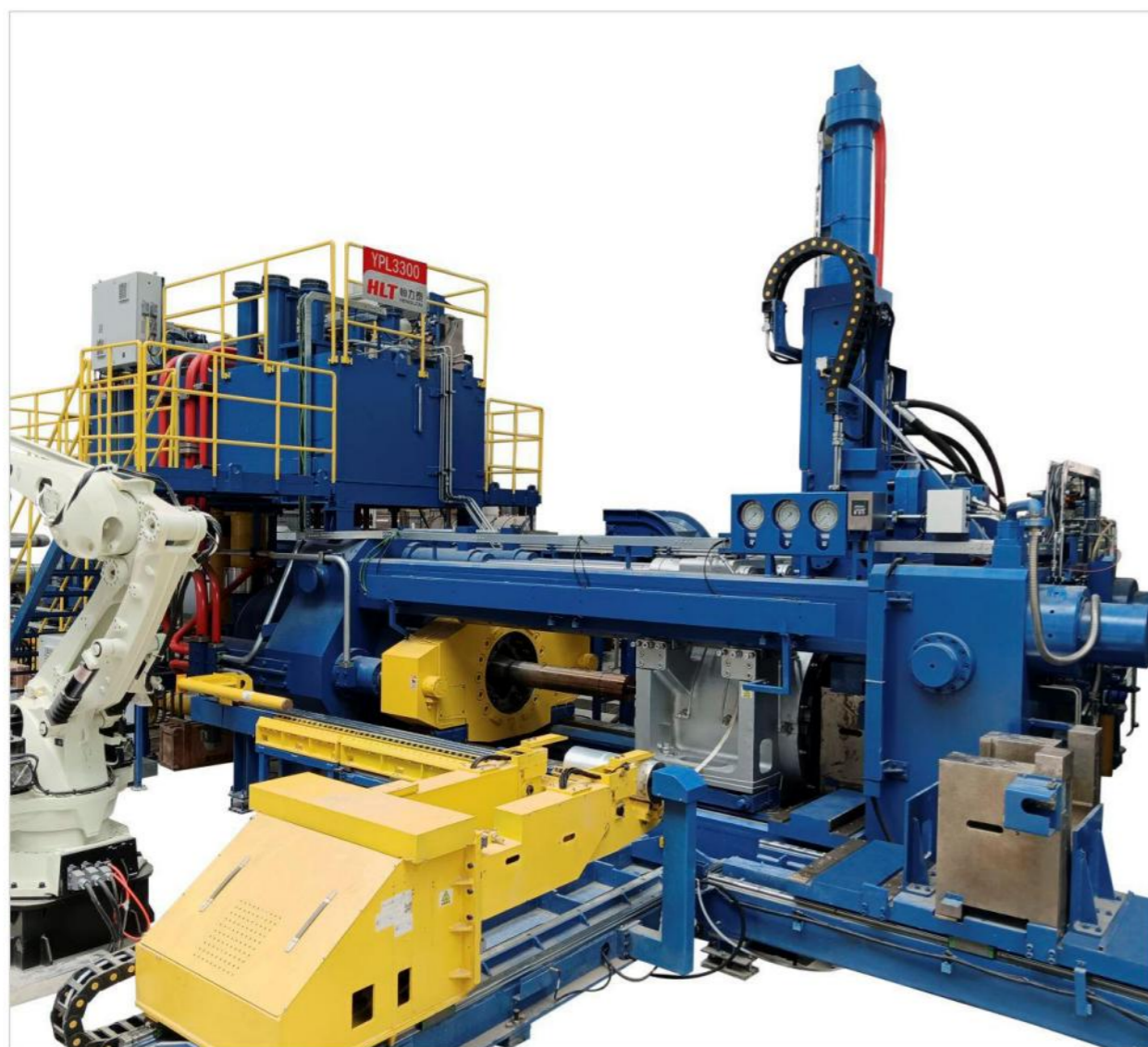

YPL3600

正向单动挤压机

SINGLE ACTION DIRECT EXTRUSION PRESS

压机结构 Press structure	上料方式 Loading method	非挤压时间 Non extrusion time	最大挤压力 (MT) Maximum extrusion force	装机功率 (kW) Installed power
短行程前上料 short stroke front loading	伺服机械手 servo billet loader	18s	3600	~860



YPL4000

正向单动挤压机

SINGLE ACTION DIRECT EXTRUSION PRESS

压机结构 Press structure	上料方式 Loading method	非挤压时间 Non extrusion time	最大挤压力 (MT) Maximum extrusion force	装机功率 (kW) Installed power
短行程前上料 short stroke front loading	伺服机械手 servo billet loader	18.5s	4000	~1000

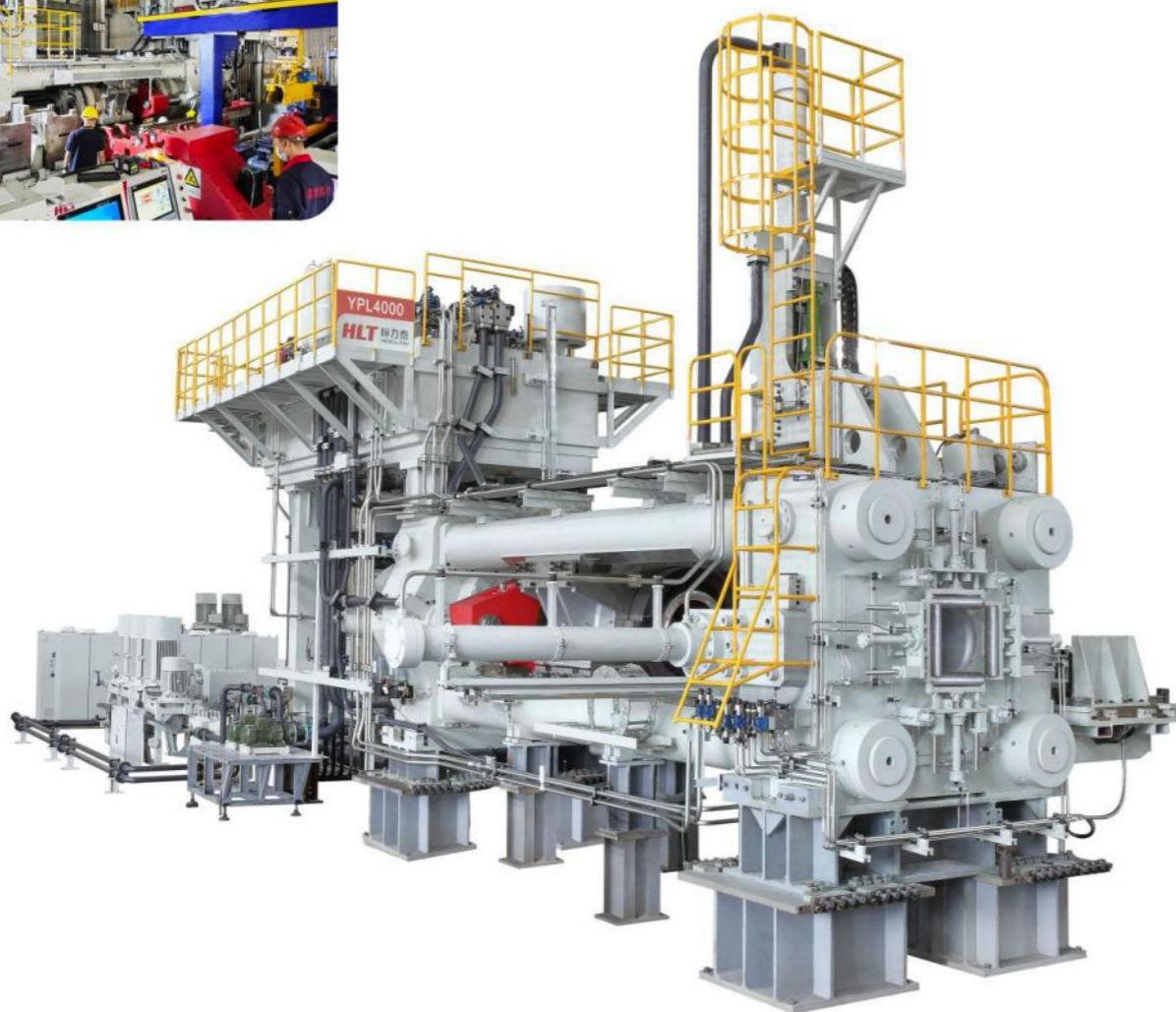

YPL6000

正向单动挤压机

SINGLE ACTION DIRECT EXTRUSION PRESS

压机结构 Press structure	上料方式 Loading method	非挤压时间 Non extrusion time	最大挤压力 (MT) Maximum extrusion force	装机功率 (kW) Installed power
短行程前上料 short stroke front loading	伺服机械手 servo billet loader	25s	6000	~1300



主机特点：

- 紧凑的结构设计，保证强度的同时，机架具有极佳的变形精度，有效保证制品的尺寸精度。
- 所有关键零部件采用FEM有限元分析，保证设备寿命及可靠性。
- 独特的主缸结构，关键部位的去应力设计，进一步降低使用风险。
- 挤压筒加热上下分区，温度分布更加均衡。

Main body features:

- Compact structural design ensures strength while has excellent deformation accuracy of the frame, effectively ensuring the dimension accuracy of the product.
- All key components are analyzed by FEM finite element method to ensure equipment life and reliability.
- Unique main cylinder structure and stress relieving design of key parts further reduce usage risks.
- The container is heated by upper and lower zone, and the temperature distribution is more uniform.

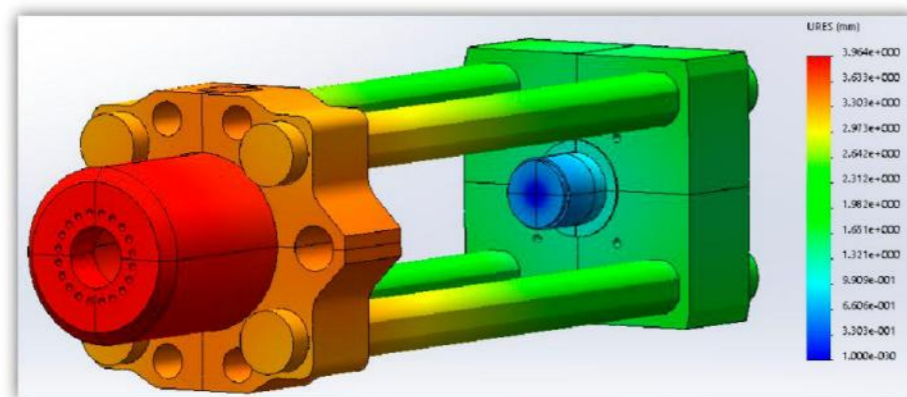
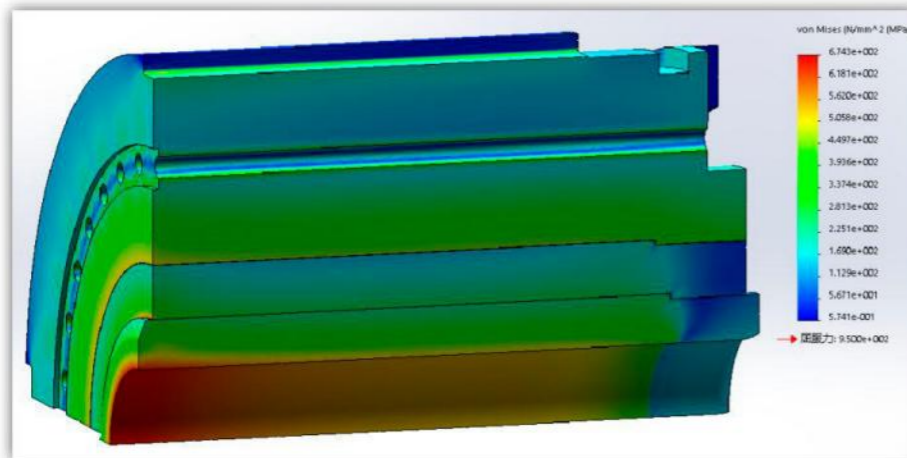

液压泵站特点：

- 采用多个高频响高精度DFEN伺服比例泵，结合变频调速，挤压恒速精度高，稳定性好，节能效果更好，在生产效率与节能方面达到了很好的平衡；
- 采用多变量泵组合方式灵活适应压机各种工况，高效节能；
- 所有高压钢管全部采用非焊接形式，密封可靠性高；

Hydraulic pump station features:

- Using multiple high-frequency response high-precision DFEN servo proportional pumps, combined with frequency conversion speed regulation, high precision for constant speed extrusion, good stability, better energy saving, reach a good balance between production efficiency and energy saving;
- Adopt multi-variable pump combination mode to flexibly adapt to various working conditions of the press, high efficiency and energy saving;
- All high-pressure steel pipes are non-welded pipes, with high sealing reliability;



ELECTRONIC SYSTEM 电气控制系统

- 电控系统采用高性能可编程控制器和国际顶级品牌电气元件，工作性能稳定可靠；
High-performance PLC and top brand electronics to ensure system reliability and stability.
- 人性化的人机界面功能丰富，可实现多种状态显示及操作提示，易于操作；
Intuitive HMI with rich functions, multiple status and operation display for easy operation.
- 完善的各种保护功能，确保操作人员人身安全和设备安全；
Plentiful safety measures to ensure personnel and equipment safety.
- 全数字化的参数设定和调整，调节方便准确；
Fully digitalized parameter setting makes it easier to adjust.
- 具备完善的故障报警和自我诊断功能，处理故障简单易行；
Alarm and self-diagnosis system for easy and effective trouble-shooting.
- 通过互联网可对压机实现远程工作状态监控、参数修改及故障诊断排除等；
Monitor of machine working condition, change of parameter and remote diagnosis, all possible via internet.

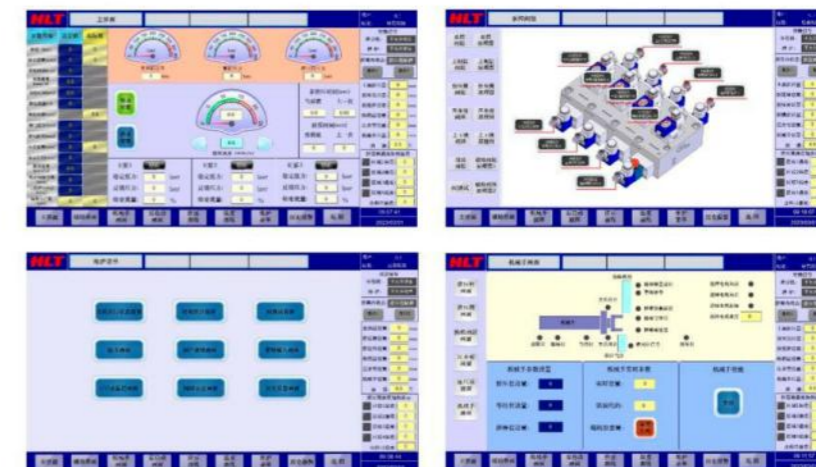

压机智能管理系统

PRESS INTELLIGENT MANAGEMENT SYSTEM

1.智能运维：运行监控，消息推送

Intelligent operation and maintenance: Operation monitoring, Notification forwarding

2.智能群组：多机组网，同步控制，生产调配

Smart grouping: Press networking, Synchronous control, Production optimization

3.智能控制：状态学习，优化控制

Intelligent control: State learning, Optimized control

4.能源管理：优化能效，节省能耗

Energy Control: Energy efficiency optimization, Energy conservation

5.数据分析：统计分析，报表生成

Data analysis: Statistics analysis, Statement generation

6.数据接口：与MES、ERP连接，数据上传

Data interface: Connects with MES, ERP, Data upload

7.远程支持：程序升级，故障排查

Remote support: Program upgrading, Trouble shooting

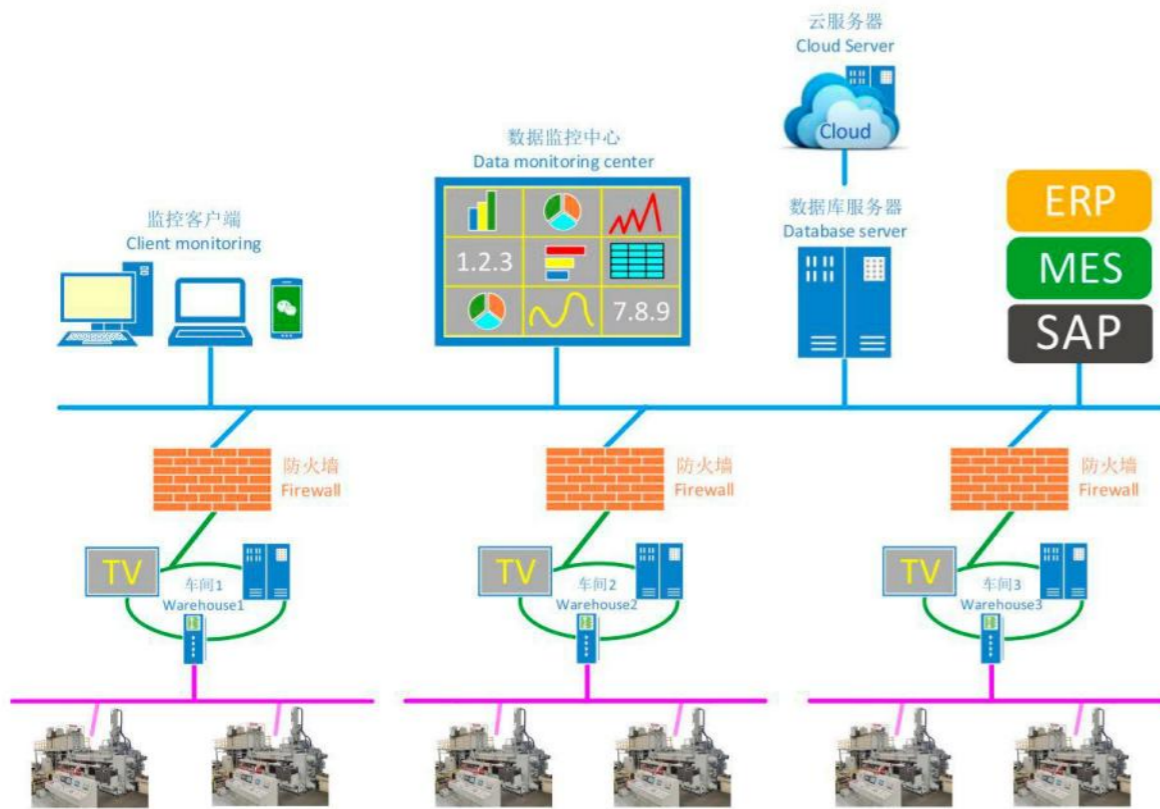

压机智能监控系统 INTELLIGENT MONITORING SYSTEM

YPL2500压机数据监控系统

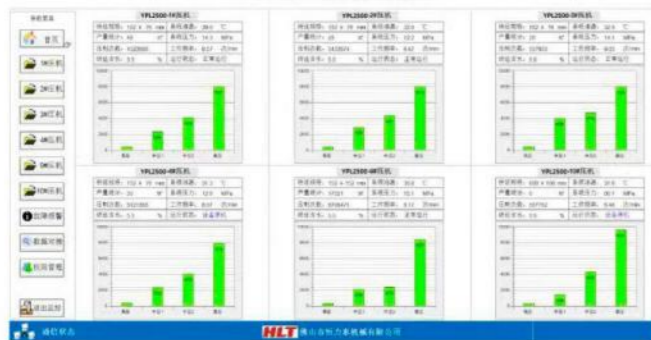

铝型材挤压机专用油

CUSTOMIZED HYDRAULIC OIL FOR ALUMINIUM EXTRUSION PRESS

L46高性能液压油 L46 high performance hydraulic oil

L68高性能液压油 L68 high performance hydraulic oil

恒力泰铝型材专用油系列采用优质基础油和多种添加剂，是专为恒力泰铝型材挤压机研发的高性能优质抗磨液压油；抗磨保护性能高，可实现液压系统的顺畅运行，提供可靠的设备保护。

HLT customized hydraulic oil of aluminium extrusion press using high-quality base oil and a variety of additives, which is specially designed for HLT aluminium extrusion press for high performance qualified anti-wear hydraulic oil, high anti-wear protection performance, it can realize the smooth operation of the hydraulic system and provide reliable equipment protection.

恒力泰铝型材挤压机专用油系列推荐用于：

HLT customized hydraulic oil of aluminium extrusion press series is recommended for:

- ◆ 尤其适用于铝型材挤压机液压系统。 ◆ Specifically suitable for aluminium profile press hydraulic system
- ◆ 普通至重载条件下的移动式及工业液压系统。 ◆ Mobile and industrial hydraulic systems under normal to heavy duty conditions
- ◆ 要求使用高品质抗磨液压油的液压系统。 ◆ Hydraulic systems that require high quality anti-wear hydraulic fluids

恒力泰铝型材挤压机专用油系列给客户带来的效益：

Benefits to customers by HLT customized hydraulic oil of aluminium extrusion press series

01 提升油品使用寿命 Prolong oil life

良好的热稳定性和氧化稳定性，在高温和高压下也能保持性能稳定；油品TOST实验可达3900小时，性能耐久性提高达3倍以上，是GB标准的3.9倍。

Good thermal and oxidation stability delivers stable performance under high temperature and high pressure. The result of TOST test is above 3900 hours. The oil durability performance is up to 3.9 times of the GB standard.

02 全面保护，延长设备使用寿命 Overall protection extend the life of equipment

良好的分水性，可减少油品的污染，保持油膜强度，保障液压系统在标准或严苛工况下可实现高效的运行。

Good water dispersion reduces oil contamination, maintain the strength of oil film, keeping high efficiency under standard and severe working conditions.

良好的空气释放性，快速的空气释放使液压系统保持高效顺畅的运行，保护系统免受油液中的空气影响，保持压力稳定传输。

Good air release property, quickly releases air from the system, ensuring high efficient and smooth hydraulic system operation, reduce the influence of air to the oil, maintain stable press transferring.

良好的防锈、防腐蚀性，在含水情况下可有效抑制腐蚀的产生，延长设备使用寿命。

Good corrosion resistance, effectively inhibits the corrosion, reduce the influence of water to the oil and extend the life of the equipment.

03 性能稳定，降低维护成本 Stable performance with lower maintenance cost

良好的抗磨保护性，保护设备元件，从而降低维护成本。

Good anti-wear performance protects the components to reduce the maintenance cost.

良好的密封弹性材料相容性，与绝大多数密封弹性材料相容，从而防止因密封不当受到侵蚀造成的漏油和污染。

Good compatibility with sealing elastic material, prevent oil from leakage and pollution caused by corrosion.



特性 Characteristic	测试方法 Method	L46	L68	性能及规格 Performance & Standard
密度(15°C), kg/L Density(15°C), kg/L	ASTM D4052	0.877	0.883	• DIN 51524 part II HLP
运动粘度(100°C), cST Kinematic Viscosity(100°C), cST	ASTM D445	6.8	8.7	• ISO 11158 HM
粘度指数 Viscosity Index	ASTM D2270	111	99	• GB 11118.1 L-HM
开口闪点(°C) Flash Point(°C)	ASTM D92	220	230	
倾点(°C) Pour Point	ASTM D97	-33	-30	
TAN, mgKOH/g	ASTM D664	0.60	0.60	
铜片腐蚀 Copper sheet corrosion	ASTM D130	1b	1b	
分水性, 40/37/3-分钟 Water separation, 40/37/3-minute	ASTM D1401	15	15	



BASIC PARAMETERS OF ALUMINUM EXTRUSION PRESS SERIES

Extrusion Force 挤压力																	
MN		11	15	20	25	27.5	30	33	36	40	45	50	55	60	65	75	100
MT		1100	1500	2000	2500	2750	3000	3300	3600	4000	4500	5000	5500	6000	6500	7500	10000
UST		1200	1650	2200	2750	3000	3300	3600	4000	4400	5000	5500	6000	6600	7150	8250	11000
Billet 铝棒		Specific Extrusion Pressure 比压力															
Container 挤压筒		kg/cm ²															
inch	mm	mm															
5	127	132	8038	10797													
6	152	158	5582	7612	10149												
7	178	184	4146	5653	7438	9422	10365										
8	203	210		4322	5763	7204	7925	8645	9509								
9	229	236			4588	5735	6308	6881	7570	8258	9175						
10	254	262				4637	5101	5565	6121	6677	7419	8347	9274				
11	279	288					4210	4592	5052	5511	6123	6889	7654	8419	9185		
12	305	314						3879	4267	4655	5172	5819	6465	7112	7758	8405	9698
13	330	339							3984	4426	4980	5533	6086	6640	7193	8300	
14	356	366								4287	4763	5239	5715	6192	7144	9526	
15	381	391									4581	4997	5413	6246	8328		
16	406	418										4364	4728	5455	7273		
17	432	445											4183	4827	6435		
18	457	471													5735		
19	483	497														5163	
20	508	524														4637	
21	533	549														4218	

挤压机技术参数 Technical parameters

公称力(公吨) Nomal force (Tons)	美吨 UST	类别 Category	系统压力 (MPa) System pressure	铝棒规格 (英寸) Aluminum bar specifications (inch)	铝棒长度 Aluminum bar length(mm)	出料口尺寸 (mm) Outlet size
1100	1200	短行程 Short stroke	30	5	700	Φ160/L200
1500	1650	短行程 Short stroke	30	6、7	900	Φ180/L230
2000	2200	短行程 Short stroke	30.5	7、8	1100	Φ230/L290
2500	2750	短行程 Short stroke	29	8、9	1350	Φ250/L350
2500	2750	短行程 Short stroke	29	8、9	1000	Φ250/L350
2750	3000	短行程 Short stroke	30.5	8、9	1150	Φ300/L400
3000	3300	短行程 Short stroke	30.5	8、9	1250	Φ310/L430
3300	3600	短行程 Short stroke	30.5	8、9、10	1250	Φ360/L460
3600	4000	短行程 Short stroke	30.5	10、11	1300	Φ330/L440
4000	4400	短行程 Short stroke	30.5	10、11、12	1400	Φ330/L440
4500	5000	短行程 Short stroke	30.5	11、12、13	1400	Φ355/L460
5000	5500	短行程 Short stroke	30.5	12、13、14	1500	Φ355/L460
5500	6000	短行程 Short stroke	30.5	13、14、15	1500	Φ420/L500
6000	6600	短行程 Short stroke	30.5	13、14、15	1500	Φ420/L580
6500	7150	短行程 Short stroke	30.5	13、14、15	1600	Φ420/L580
7500	8250	短行程 Short stroke	30.5	14、15、16	1600	Φ670/L740
10000	11000	短行程 Short stroke	30.5	17、18、19、20	1800	Φ650/L900

资料机型参数为佛山市恒力泰机械有限公司版权所有。如有修改，恕不另外通知。
The data and model parameters are copyrighted by HLT Industry CO., LTD. and are subject to change without notice.

- 前/后上料挤压作业对比，前上料挤压质量更均匀
- Comparison of front/back loading and extrusion operations shows that the quality of front feeding and extrusion is more uniform

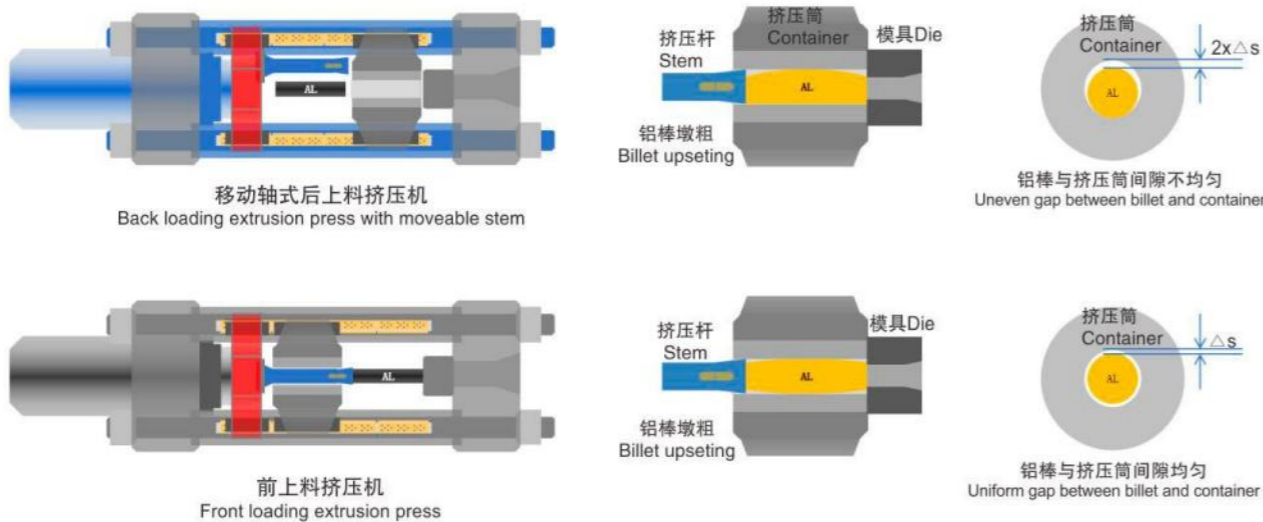

遍布全国的**19**个国内服务配件网点
国外已建立**3**个服务配件网点



服务宗旨: 优质服务顾客满意

服务理念: 服务创造价值

服务方针: 专业、高效、优质、满意

服务承诺: ①提供24小时全天候服务。②有求必应，有应必果。③反应快速，解决问题。

一直以来，恒力泰始终坚持以客户利益为先，以优异的品质、专业的服务 两大核心优势获得国内外客户的青睐。自铝型材挤压机推出市场以来，得到了国内知名企业的肯定和信赖，并远销到欧洲

HLT has always insisted on putting customer interests first, and has won the favor of domestic and foreign customers with its two core advantages of excellent quality and professional service. Since the aluminum extrusion press was launched on the market, it has been recognized and trusted by well-known domestic companies, and has been exported to Europe.



注:排名不分先后
Note: The above companies (names are arranged) in random order